

**SITUACIÓ**  
S/E

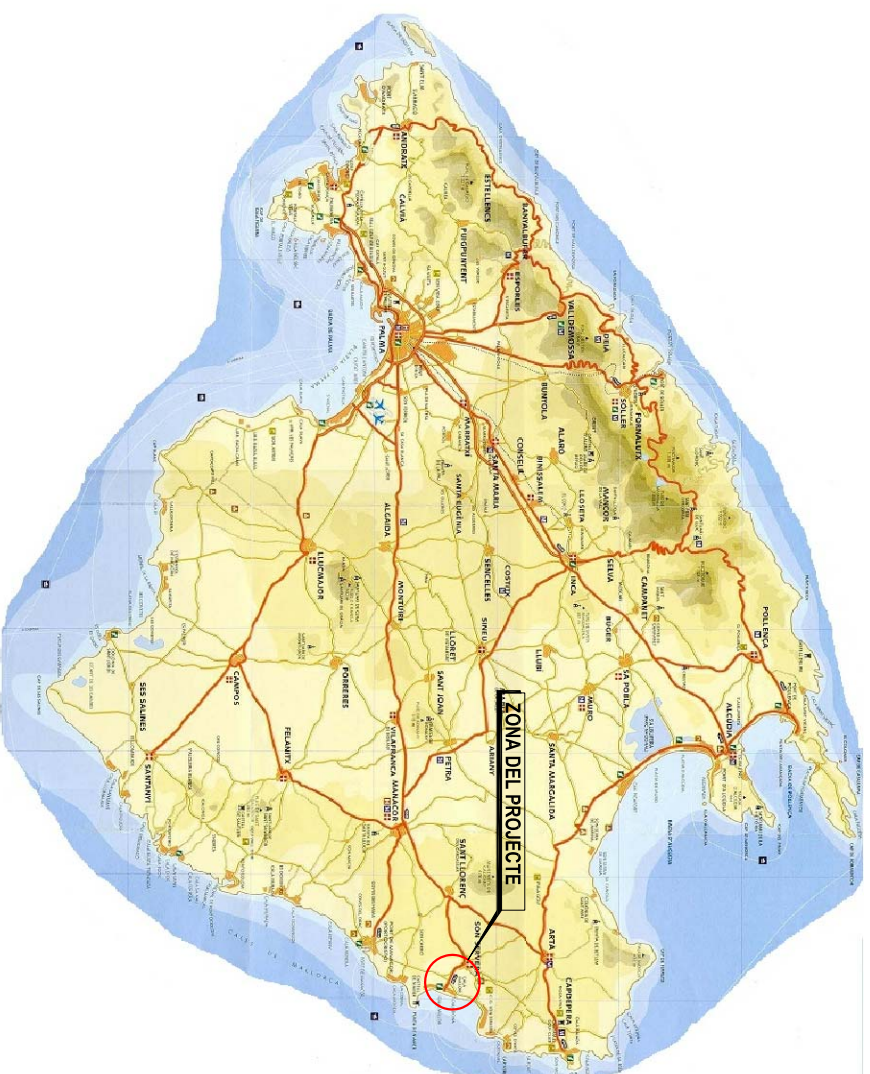

**SITUACIÓ DETALLADA**  
S/E



<b>TÍTULO DEL PROYECTO/TÍTOL DEL PROJECTE :</b> SUBSTITUCIÓ I MILLORA DE LA XARXA DE SANEJAMENT I EMISSARI TERRESTRE DE SON SERVERA.	<b>AUTOR DEL PROYECTO/AUTOR DEL PROJECTE:</b> ANTONI BERNAT HOMAR, Ingeniero Caminos, C. y P. N.º col.: 15.786.	<b>FECHA/DATA:</b> NOVIEMBRE 2015	<b>ESCALAS/ESCALES:</b> DIN A1: S/E. DIN A3: S/E.	<b>TÍTULO DEL PLANO/TÍTOL DEL PLANOL:</b> SITUACIÓ GENERAL I EMPLAÇAMENT	<b>Nº PLANO/Nº PLANOL:</b> 1 1 de 1
-----------------------------------------------------------------------------------------------------------------------------------------	-----------------------------------------------------------------------------------------------------------------------	-----------------------------------------	---------------------------------------------------------	-----------------------------------------------------------------------------	-------------------------------------------

## ESTUDIO DE SEGURIDAD Y SALUD

TÍTULO DEL PLANO:

SEÑALIZACIÓN Y BALIZAMIENTO

Nº PLANO: 3

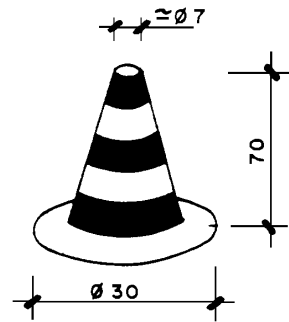

CONO BALIZAMIENTO

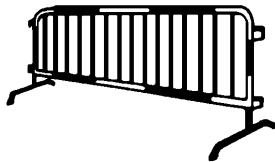

VALLAS DESVIO TRAFICO



CINTA BALIZAMIENTO

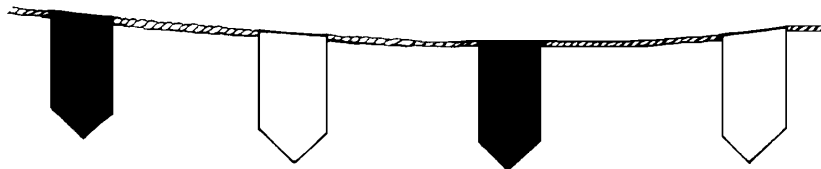

CORDON BALIZAMIENTO

## ESTUDIO DE SEGURIDAD Y SALUD

TÍTULO DEL PLANO:

PASARELA SOBRE ZANJA

Nº PLANO: 4

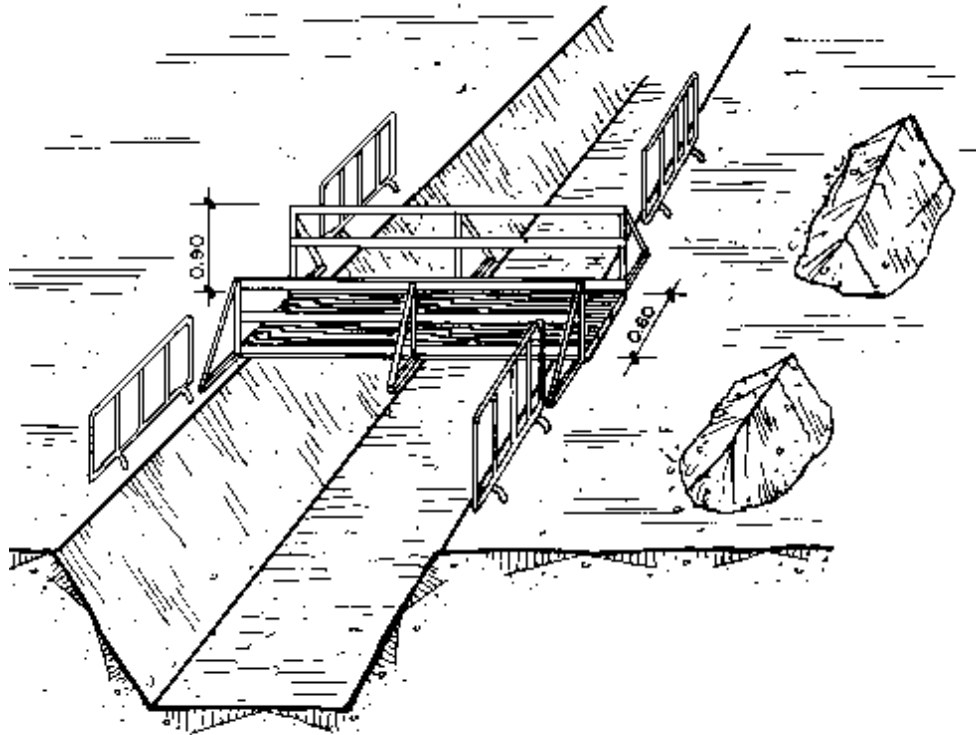

## ESTUDIO DE SEGURIDAD Y SALUD

TÍTULO DEL PLANO:

TOPE DE RETROCESO

Nº PLANO: 5

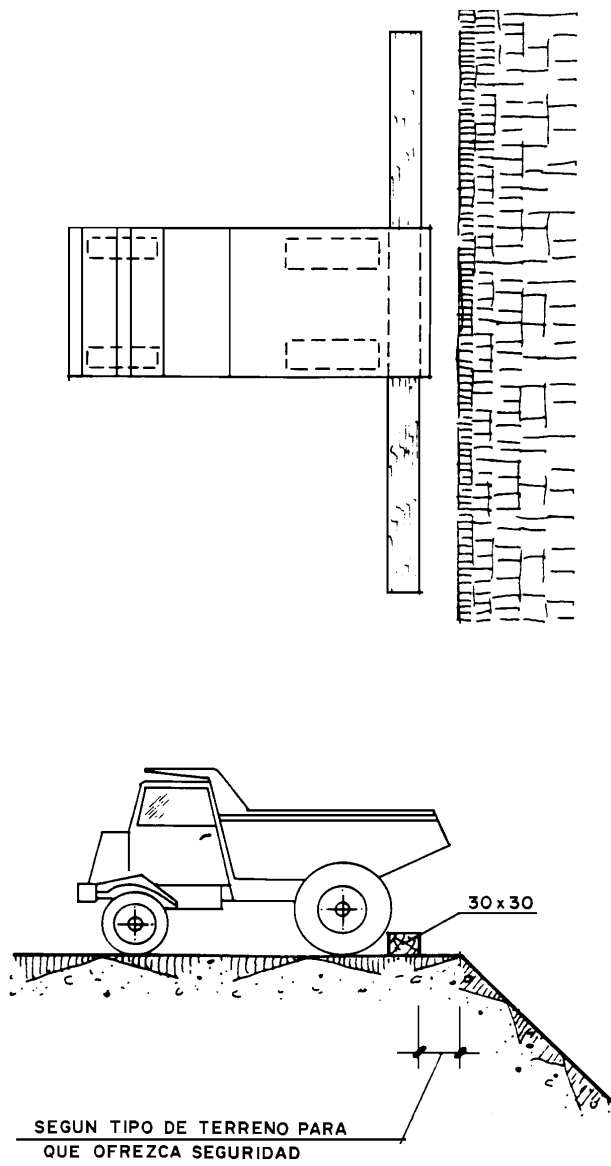

**ESTUDIO DE SEGURIDAD Y SALUD**

**TÍTULO DEL PLANO:**

*BARANDA DE PROTECCIÓN*

**Nº PLANO:** 6

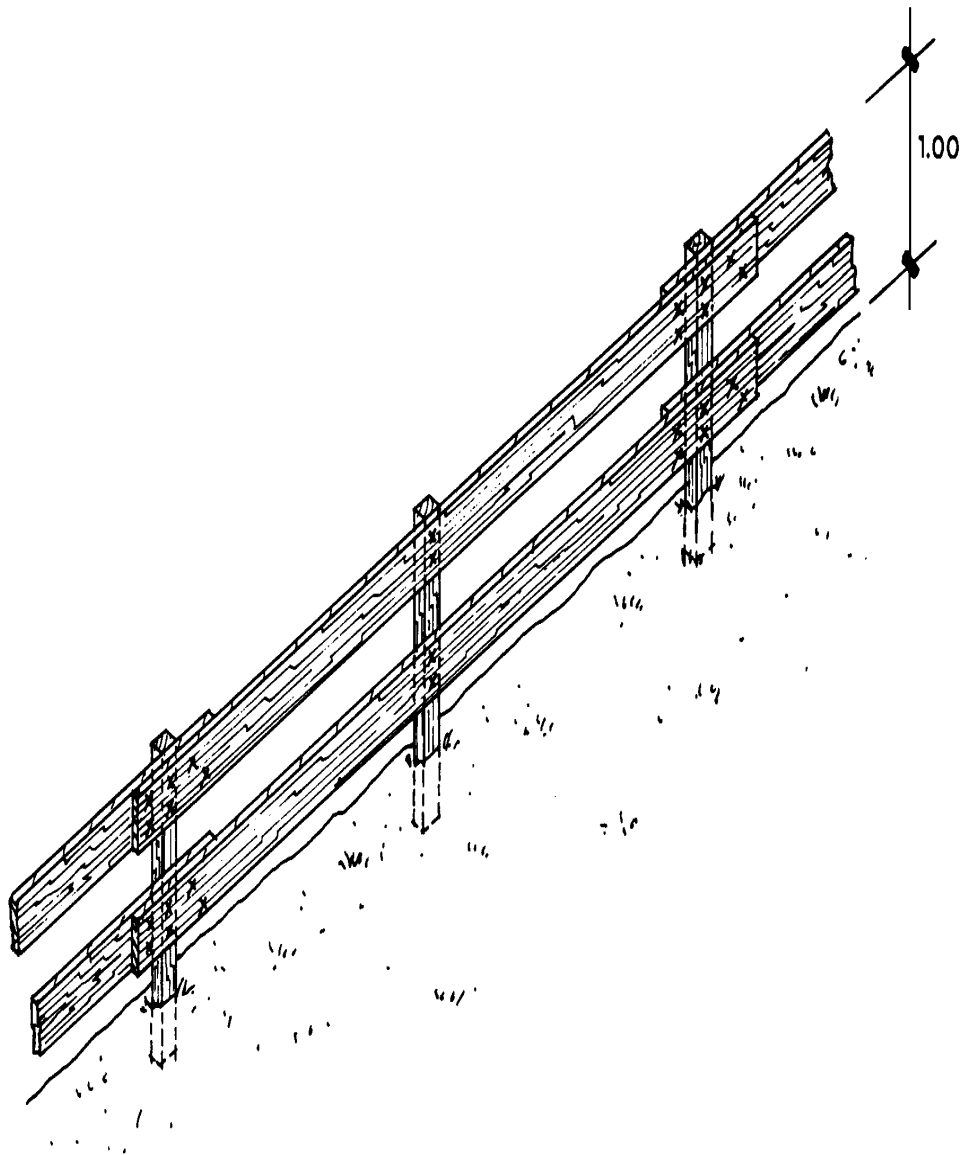

## ESTUDIO DE SEGURIDAD Y SALUD

TÍTULO DEL PLANO:

SEÑALIZACIÓN

Nº PLANO: 7



7000 SALIDA DE EMERGENCIA



7001 BARRA ANTIPÁNICO



7002 EMPUJAR PARA SALIR



7005 DESLIZAR PARA ABRIR

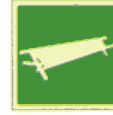

7006 CAMILLA SOCORRO



7010 VIA DE EVACUACION



7015 EXTINTOR



7016 BOCA DE INCENDIO



7017 MATERIAL CONTRA INCENDIO



7030 CUBO PARA INCENDIO



7032 ESCALERA DE INCENDIO



7035 PULSADOR DE ALARMA



7036 AVISADOR SONORO



7051 PAPELERA



7054 TELEFONO EMERGENCIA



7055 VIA MATERIAL CONTRA INCENDIO



7056 VIA MATERIAL CONTRA INCENDIO

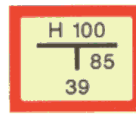

7058 HIDRANTE



7059 COLUMNA MOVIL DE EXTINCION



7060 MANTA APAGAFUEGOS

## ESTUDIO DE SEGURIDAD Y SALUD

TÍTULO DEL PLANO:

SEÑALIZACIÓN

Nº PLANO: 8



9000



9030



9001



9002



9003



9004



9005



9006



9007



9008



9009



9010

## ESTUDIO DE SEGURIDAD Y SALUD

TÍTULO DEL PLANO:

SEÑALIZACIÓN

Nº PLANO: 9

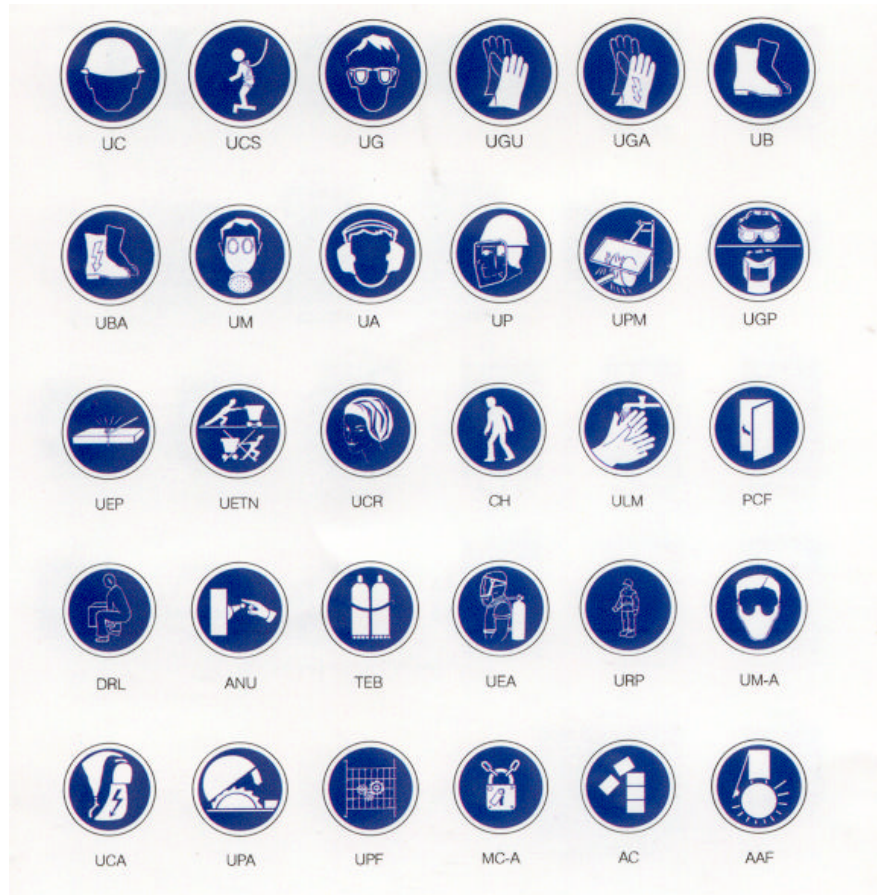



## ESTUDIO DE SEGURIDAD Y SALUD

TÍTULO DEL PLANOL:

SEÑALIZACIÓN

Nº PLANO: 10



**ESTUDIO DE SEGURIDAD Y SALUD**

TÍTULO DEL PLANO:

SEÑALIZACIÓN

Nº PLANO: 11

